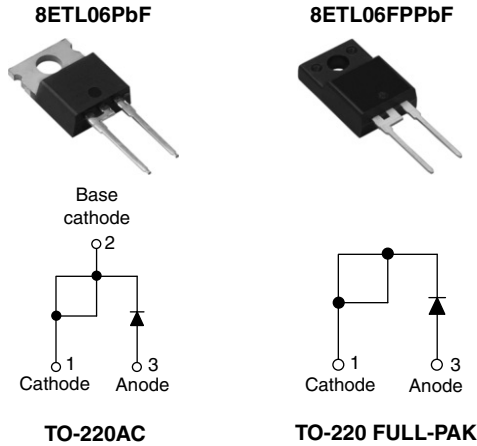

Ultralow V_F Hyperfast Rectifier for Discontinuous Mode PFC, 8 A FRED Pt™

FEATURES

- Benchmark ultralow forward voltage drop
- Hyperfast recovery time
- Low leakage current
- 175 °C operating junction temperature
- Fully isolated package ($V_{INS} = 2500 V_{RMS}$)
- UL E78996 approved
- Lead (Pb)-free
- Designed and qualified for industrial level

RoHS*
COMPLIANT

DESCRIPTION

State of the art, ultralow V_F , soft-switching hyperfast rectifiers optimized for Discontinuous (Critical) Mode (DCM) Power Factor Correction (PFC).

The minimized conduction loss, optimized stored charge and low recovery current minimize the switching losses and reduce over dissipation in the switching element and snubbers.

The device is also intended for use as a freewheeling diode in power supplies and other power switching applications.

APPLICATIONS

AC-DC SMPS 70 W to 400 W
e.g. laptop and printer AC adaptors, desktop PC, TV and monitor, games units and DVD AC-DC power supplies.

PRODUCT SUMMARY

V_F (typical)	0.96 V
$I_{F(AV)}$	8 A
V_R	600 V

ABSOLUTE MAXIMUM RATINGS

PARAMETER	SYMBOL	TEST CONDITIONS	VALUES	UNITS
Repetitive peak reverse voltage	V_{RRM}		600	V
Average rectified forward current	$I_{F(AV)}$	$T_C = 160\text{ °C}$	8	A
FULL-PAK		$T_C = 142\text{ °C}$		
Non-repetitive peak surge current	I_{FSM}	$T_J = 25\text{ °C}$	175	
Repetitive peak forward current	I_{FM}		16	
Operating junction and storage temperatures	T_J, T_{Stg}		- 65 to 175	°C

ELECTRICAL SPECIFICATIONS ($T_J = 25\text{ °C}$ unless otherwise specified)

PARAMETER	SYMBOL	TEST CONDITIONS	MIN.	TYP.	MAX.	UNITS
Breakdown voltage, blocking voltage	V_{BR}, V_R	$I_R = 100\ \mu A$	600	-	-	V
Forward voltage	V_F	$I_F = 8\text{ A}$	-	0.96	1.05	
		$I_F = 8\text{ A}, T_J = 150\text{ °C}$	-	0.81	0.86	
Reverse leakage current	I_R	$V_R = V_R$ rated	-	0.05	5	μA
		$T_J = 150\text{ °C}, V_R = V_R$ rated	-	20	100	
Junction capacitance	C_T	$V_R = 600\text{ V}$	-	17	-	pF
Series inductance	L_S	Measured lead to lead 5 mm from package body	-	8.0	-	nH

* Pb containing terminations are not RoHS compliant, exemptions may apply

8ETL06PbF, 8ETL06FPPbF



Vishay High Power Products

Ultralow V_F Hyperfast Rectifier for
Discontinuous Mode PFC, 8 A FRED Pt™

DYNAMIC RECOVERY CHARACTERISTICS ($T_C = 25\text{ °C}$ unless otherwise specified)						
PARAMETER	SYMBOL	TEST CONDITIONS	MIN.	TYP.	MAX.	UNITS
Reverse recovery time	t_{rr}	$I_F = 1\text{ A}$, $di_F/dt = 100\text{ A}/\mu\text{s}$, $V_R = 30\text{ V}$	-	60	100	ns
		$I_F = 8\text{ A}$, $di_F/dt = 100\text{ A}/\mu\text{s}$, $V_R = 30\text{ V}$	-	150	250	
		$T_J = 25\text{ °C}$	-	170	-	
		$T_J = 125\text{ °C}$	-	250	-	
Peak recovery current	I_{RRM}	$T_J = 25\text{ °C}$	-	15	-	A
		$T_J = 125\text{ °C}$	-	20	-	
Reverse recovery charge	Q_{rr}	$T_J = 25\text{ °C}$	-	1.3	-	μC
		$T_J = 125\text{ °C}$	-	2.6	-	

THERMAL - MECHANICAL SPECIFICATIONS						
PARAMETER	SYMBOL	TEST CONDITIONS	MIN.	TYP.	MAX.	UNITS
Maximum junction and storage temperature range	T_J , T_{Stg}		- 65	-	175	$^{\circ}\text{C}$
Thermal resistance, junction to case (FULL-PAK)	R_{thJC}		-	1.4	2	$^{\circ}\text{C}/\text{W}$
			-	3.4	4.3	
Thermal resistance, junction to ambient per leg	R_{thJA}	Typical socket mount	-	-	70	
Thermal resistance, case to heatsink	R_{thCS}	Mounting surface, flat, smooth and greased	-	0.5	-	
Weight			-	2.0	-	g
			-	0.07	-	oz.
Mounting torque			6.0 (5.0)	-	12 (10)	kgf · cm (lb · in)
Marking device		Case style TO-220AC	8ETL06			
		Case style TO-220 FULL-PAK	8ETL06FP			



8ETL06PbF, 8ETL06FPPbF

Ultralow V_F Hyperfast Rectifier for
Discontinuous Mode PFC, 8 A FRED Pt™

Vishay High Power Products

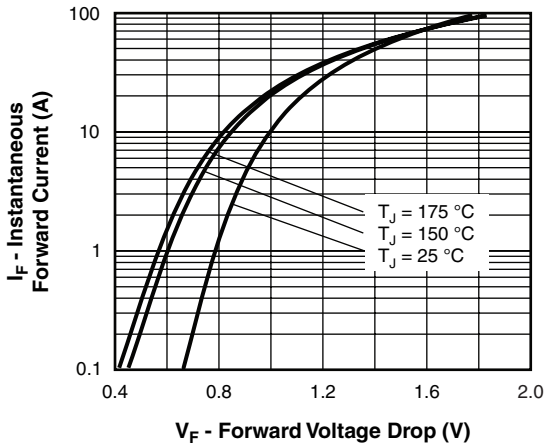

Fig. 1 - Typical Forward Voltage Drop Characteristics

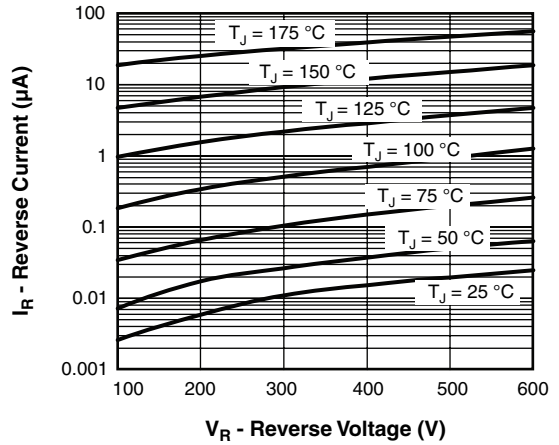

Fig. 2 - Typical Values of Reverse Current vs. Reverse Voltage

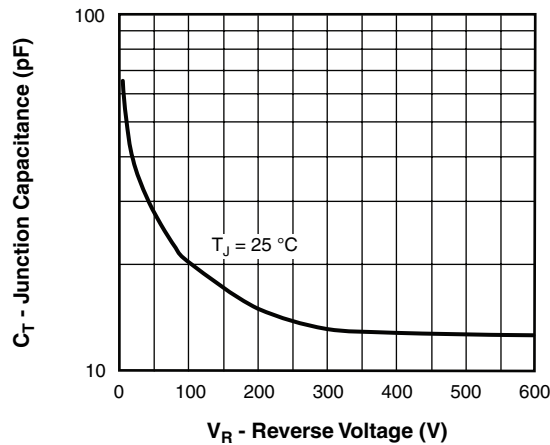

Fig. 3 - Typical Junction Capacitance vs. Reverse Voltage

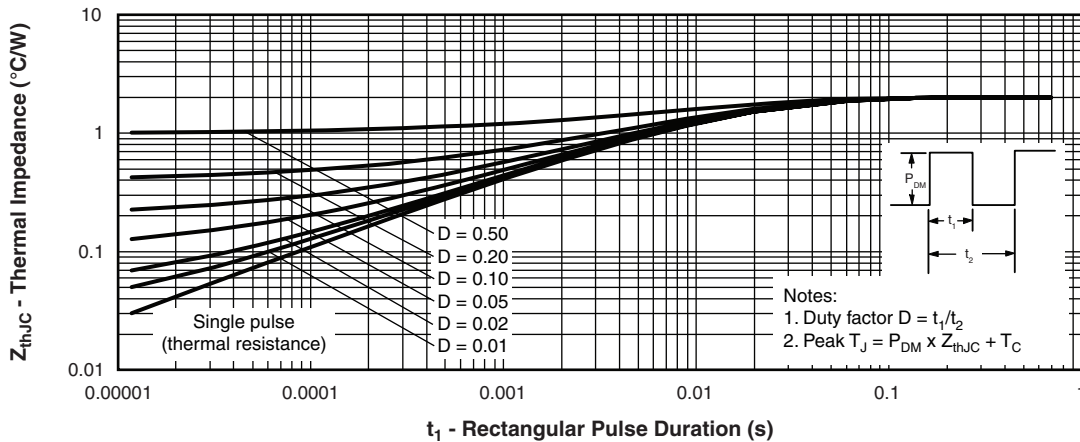

Fig. 4 - Maximum Thermal Impedance Z_{thJC} Characteristics

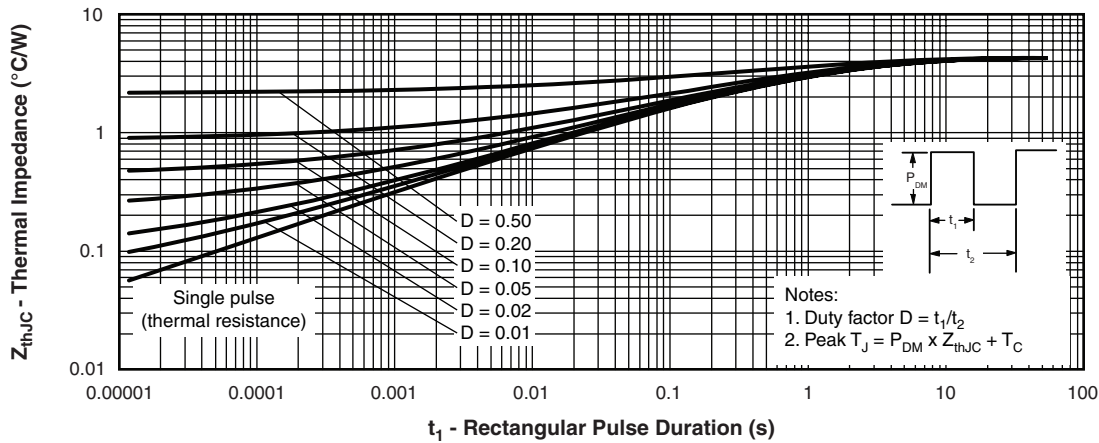

Fig. 5 - Maximum Thermal Impedance Z_{thJC} Characteristics (FULL-PAK)

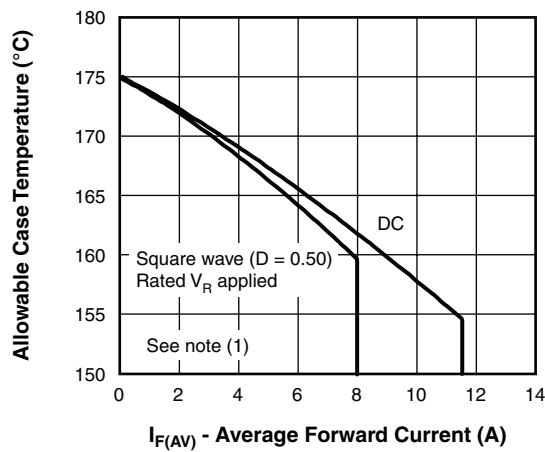

Fig. 6 - Maximum Allowable Case Temperature vs. Average Forward Current

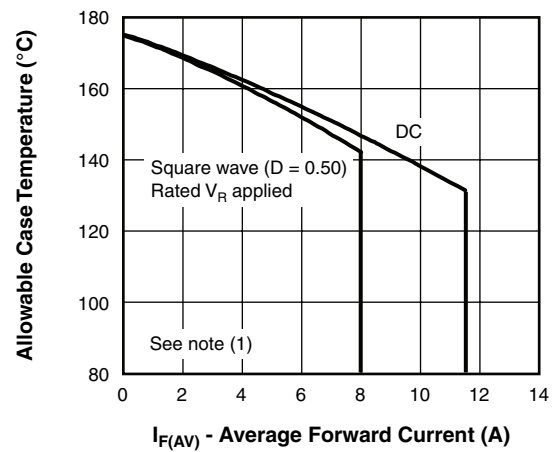

Fig. 7 - Maximum Allowable Case Temperature vs. Average Forward Current (FULL-PAK)

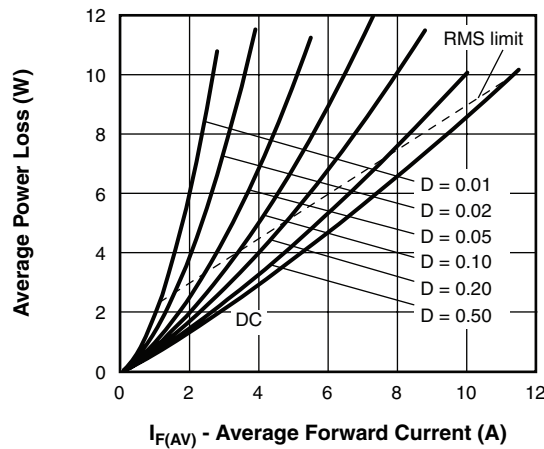

Fig. 8 - Forward Power Loss Characteristics

Note

- (1) Formula used: $T_C = T_J - (P_d + P_{dREV}) \times R_{thJC}$
 P_d = Forward power loss = $I_{F(AV)} \times V_{FM}$ at $(I_{F(AV)}/D)$ (see fig. 8);
 P_{dREV} = Inverse power loss = $V_{R1} \times I_R (1 - D)$; I_R at V_{R1} = Rated V_R

Ultralow V_F Hyperfast Rectifier for Discontinuous Mode PFC, 8 A FRED Pt™

Vishay High Power Products

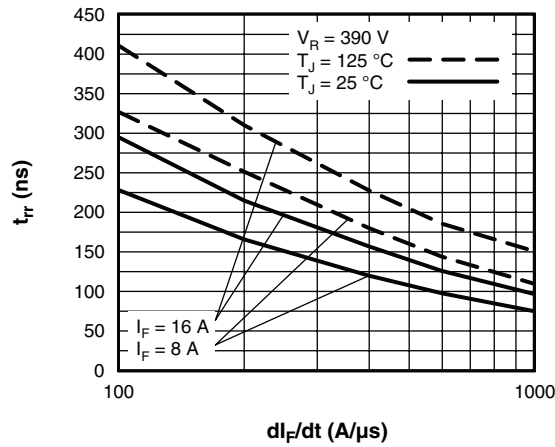

Fig. 9 - Typical Reverse Recovery Time vs. di_F/dt

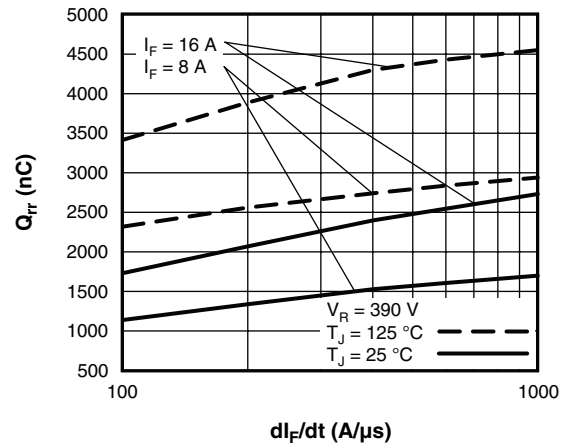

Fig. 10 - Typical Stored Charge vs. di_F/dt

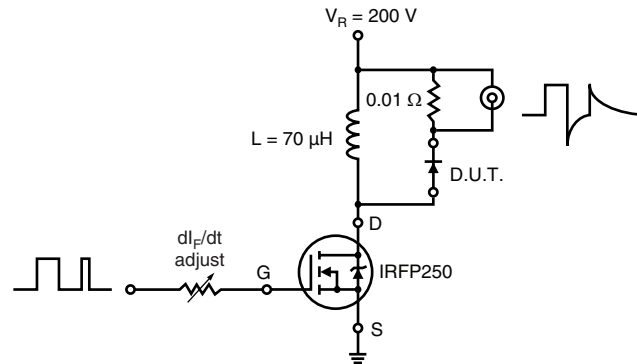
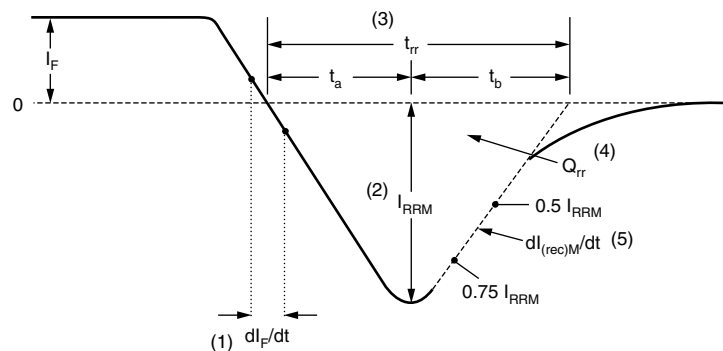

Fig. 11 - Reverse Recovery Parameter Test Circuit



(1) di_F/dt - rate of change of current through zero crossing

(2) I_{RRM} - peak reverse recovery current

(3) t_{rr} - reverse recovery time measured from zero crossing point of negative going I_F to point where a line passing through $0.75 I_{RRM}$ and $0.50 I_{RRM}$ extrapolated to zero current.

(4) Q_{rr} - area under curve defined by t_{rr} and I_{RRM}

$$Q_{rr} = \frac{t_{rr} \times I_{RRM}}{2}$$

(5) $dl_{(rec)M}/dt$ - peak rate of change of current during t_b portion of t_{rr}

Fig. 12 - Reverse Recovery Waveform and Definitions

8ETL06PbF, 8ETL06FPPbF



Vishay High Power Products

Ultralow V_F Hyperfast Rectifier for
Discontinuous Mode PFC, 8 A FRED Pt™

ORDERING INFORMATION TABLE

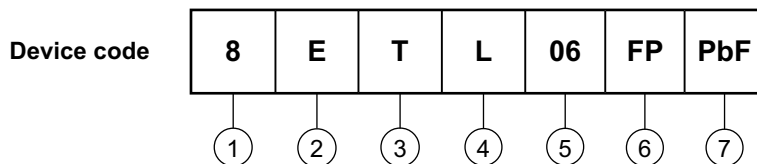

- 1** - Current rating (8 = 8 A)
- 2** - E = Single diode
- 3** - T = TO-220, D²PAK
- 4** - L = Ultralow V_F hyperfast recovery
- 5** - Voltage rating (06 = 600 V)
- 6** -
 - None = TO-220AC
 - FP = TO-220 FULL-PAK
- 7** -
 - None = Standard production
 - PbF = Lead (Pb)-free

Tube standard pack quantity: 50 pieces

LINKS TO RELATED DOCUMENTS	
Dimensions	http://www.vishay.com/doc?95039
Part marking information	http://www.vishay.com/doc?95045



Disclaimer

All product specifications and data are subject to change without notice.

Vishay Intertechnology, Inc., its affiliates, agents, and employees, and all persons acting on its or their behalf (collectively, "Vishay"), disclaim any and all liability for any errors, inaccuracies or incompleteness contained herein or in any other disclosure relating to any product.

Vishay disclaims any and all liability arising out of the use or application of any product described herein or of any information provided herein to the maximum extent permitted by law. The product specifications do not expand or otherwise modify Vishay's terms and conditions of purchase, including but not limited to the warranty expressed therein, which apply to these products.

No license, express or implied, by estoppel or otherwise, to any intellectual property rights is granted by this document or by any conduct of Vishay.

The products shown herein are not designed for use in medical, life-saving, or life-sustaining applications unless otherwise expressly indicated. Customers using or selling Vishay products not expressly indicated for use in such applications do so entirely at their own risk and agree to fully indemnify Vishay for any damages arising or resulting from such use or sale. Please contact authorized Vishay personnel to obtain written terms and conditions regarding products designed for such applications.

Product names and markings noted herein may be trademarks of their respective owners.